

ECHELON PLUS[®]

Ornamental Aluminum Fence



FENCE PRODUCTS

AMERISTARFENCE.COM | 888-333-3422

Experience a safer and more open world

AMERISTAR[®]

ASSA ABLOY



ECHELON PLUS[®]

ORNAMENTAL ALUMINUM FENCE



Echelon Plus has taken the quality and performance of aluminum ornamental fencing to a higher level. The strength characteristics of the reinforced rail and posts, coupled with a superior powder coat finish, make Echelon Plus the most durable .75" ornamental picket product on the market.

The sleek design and superior quality of Echelon Plus is International Building Code (IBC) compliant.

- Exceeds all IBC 2018 Handrail & Guards load requirements
- Standard 8 ft. panels yield project savings
- Redesigned rail for increased strength and maximum load capacity

FORERUNNER® LOCKING SYSTEM

Ameristar reengineered the Echelon Plus ForeRunner rail to maximize strength. The innovative design of the ForeRunner rail contains an internally-secured rod that allows for variable pitch connection and high-angle biasability and eliminates the need for external fasteners.

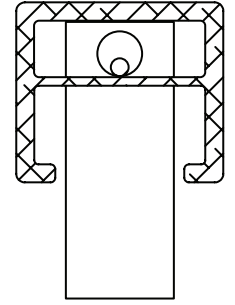

Rail Cross Section

Increased security

The ForeRunner rail, with an internal retaining rod, prevents the attachment from being compromised. Fasteners are not exposed.

Aesthetic details

The “Good Neighbor Design” rod follows the ForeRunner centerline, providing a clean and uninterrupted look void of visible screws or rivets.

RAKEABLE VS STAIR-STEP

Having a unique picket to rail connection allows Echelon products a minimum biasability of 10%, eliminating any possible security risks due to large gaps under the fence panels.

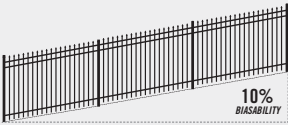

FULLY RAKEABLE PANELS

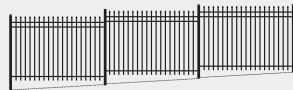

STAIR-STEPPING PANELS



GROMMET

Aesthetic appearance while preventing moisture collection

INTERNAL RETAINING ROD

Variable pitch connection system provides ease of installation, high-angle biasability and eliminates unsightly external fasteners

FORERUNNER RAIL

Reengineered for optimal performance and strength

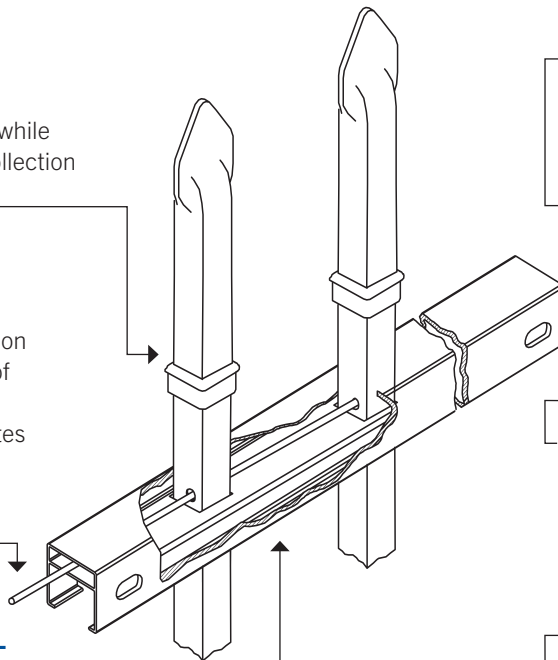

REINFORCED POST

Center rib increases strength against wind loading and other horizontally applied forces

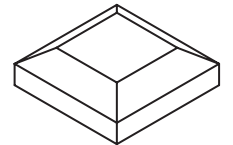

PANEL BRACKET

Universal Boulevard Bracket enables easy installation while allowing for adjustment of panel height and positioning

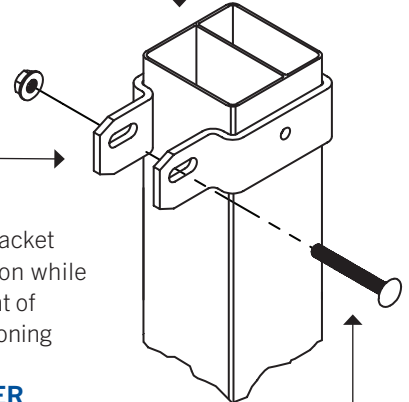

SECURITY FASTENER

Security fastener secures the rail and deters removal by typical tools

NO RIVETS. NO SCREWS. NO WELDS.

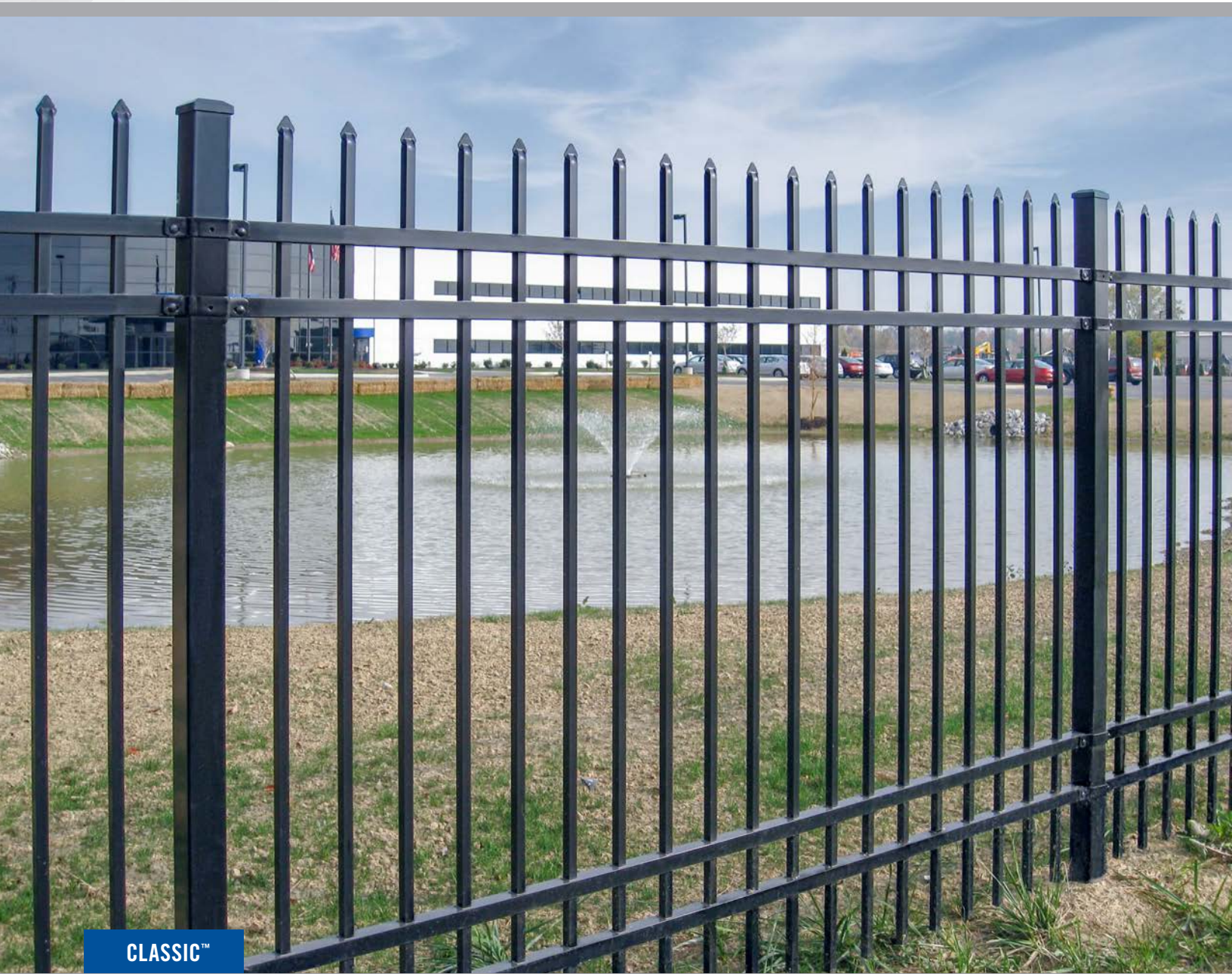

CLASSIC™

STYLES



CLASSIC™



MAJESTIC™



GENESIS™



CONQUEROR™



WARRIOR™

Note: Classic, Majestic, Genesis & Warrior 3- & 4-rail panels are IBC compliant.

BOTTOM OPTION



**STANDARD
BOTTOM
RAIL**



**FLUSH
BOTTOM
RAIL**

PICKETS

.75" SQ. x .045"

RAILS

1.4375" x 1.25" x (.110" SIDE / .090" TOP)
FORERUNNER® RAILS

POSTS

2.5" SQ. x .060"
With reinforced internal web.

HEIGHTS

3', 3½', 4', 4½', 5', 6'
Custom heights also available.



MAJESTIC™

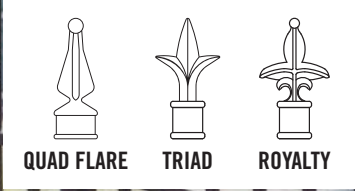
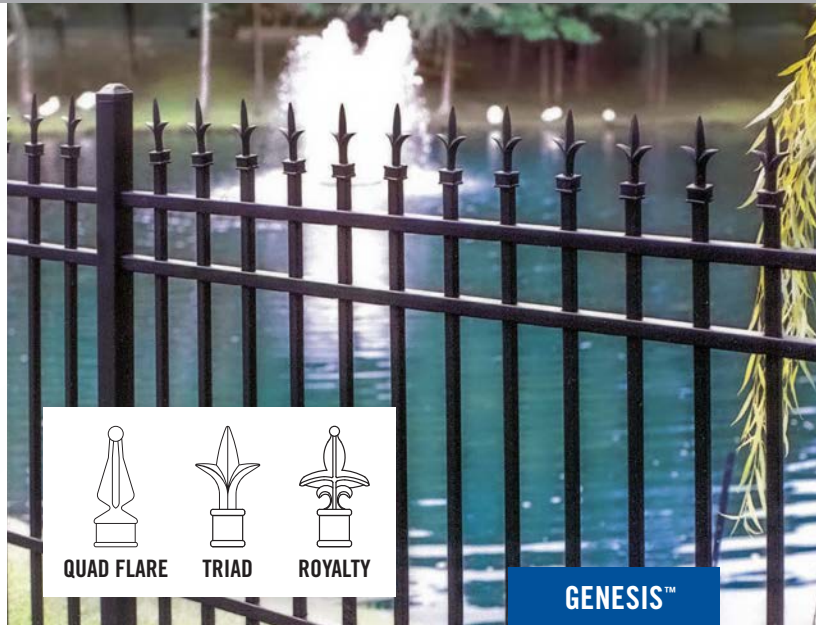

QUAD FLARE

TRIAD

ROYALTY

GENESIS™

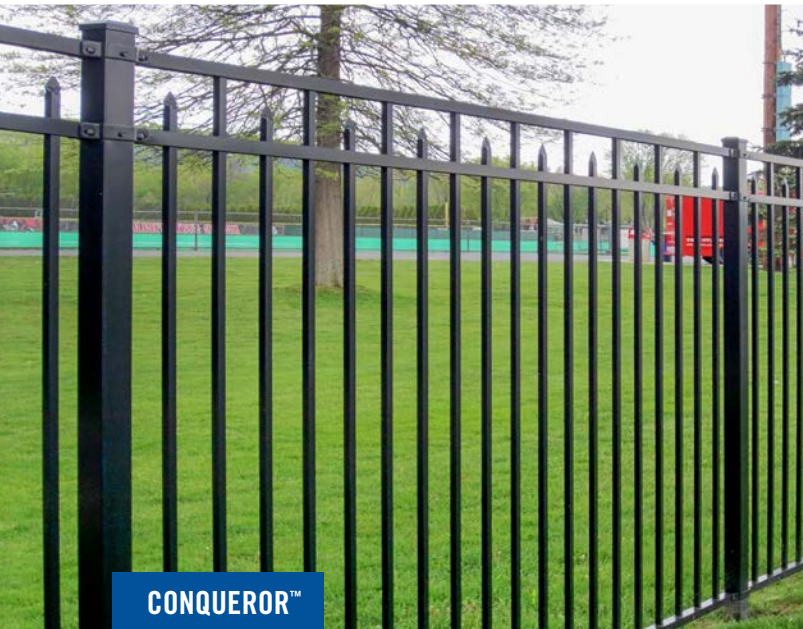

CONQUEROR™

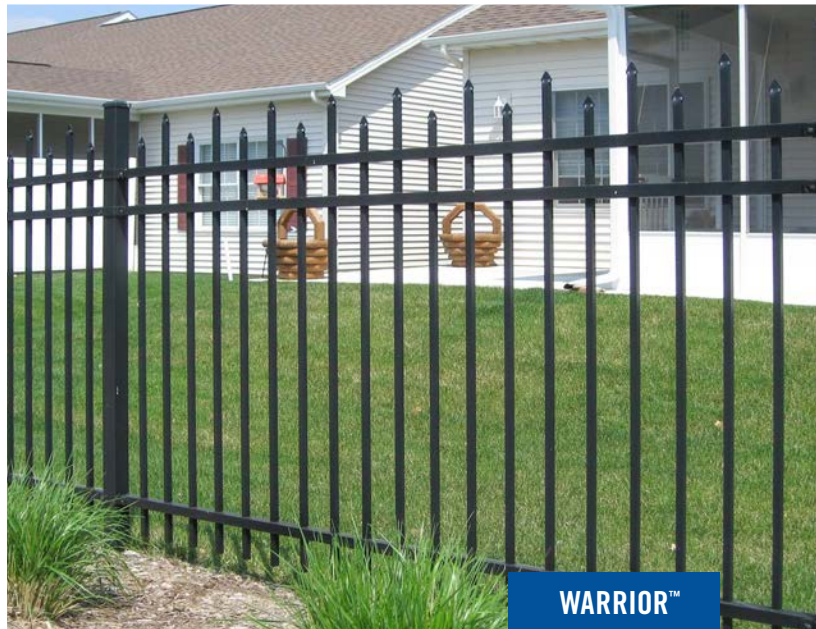

WARRIOR™

PANELS

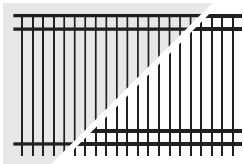

**3-RAIL & 4-RAIL
PANELS
AVAILABLE**

COLORS



BLACK BRONZE WHITE

*Custom colors also available.
Refer to color sample for actual color.*

ADORNMENTS



BALL CAP



RING
(internally secured)

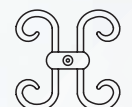

**BUTTERFLY
SCROLL**

POOL & PET PERFORMANCE

In many cases, particularly in relation to pool safety, a **specific rail spacing** is essential, while the containment of small pets requires a **narrower picket spacing**.

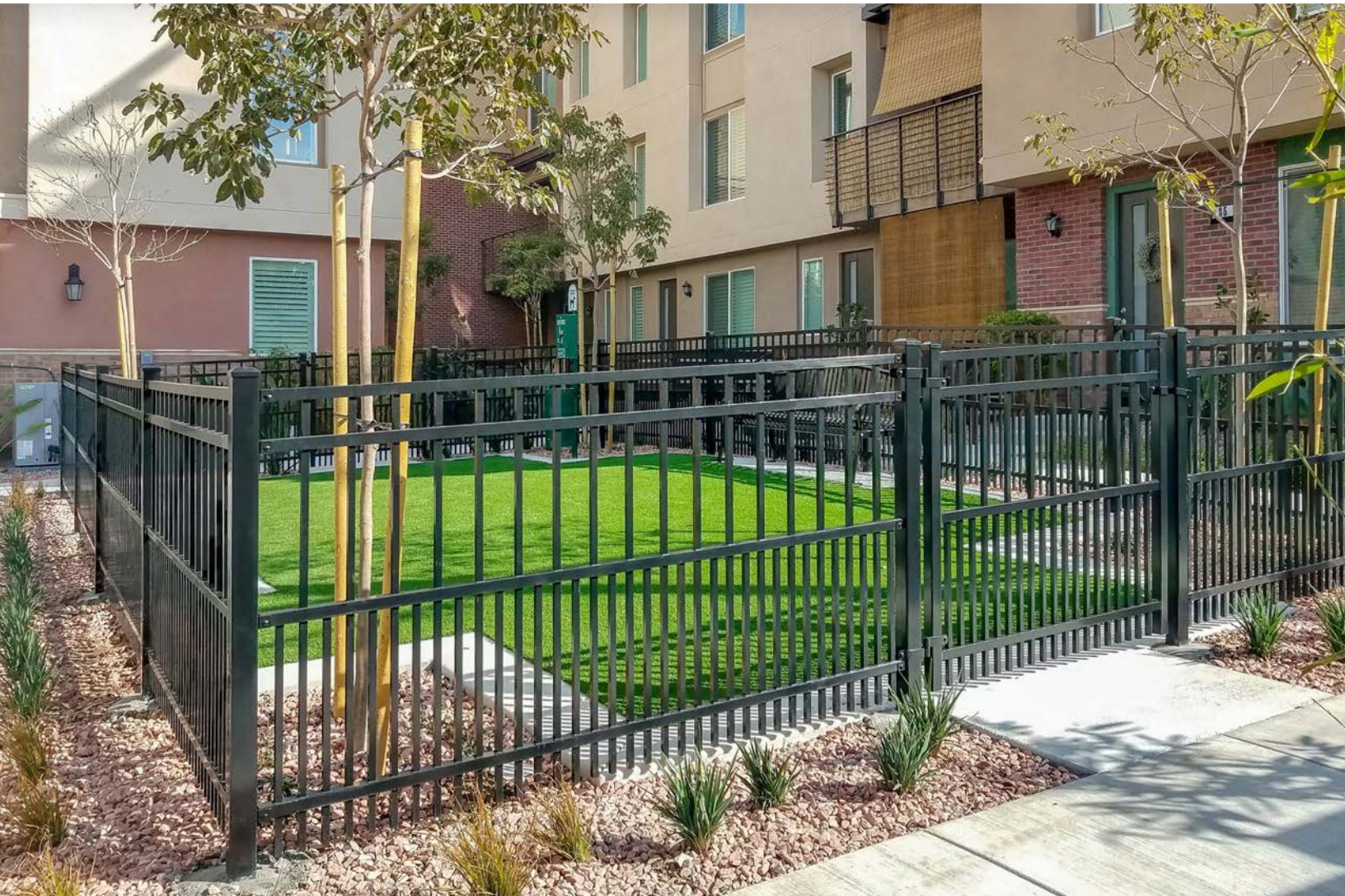

PUPPY PANELS

Echelon Plus Puppy Panels reduce the space between pickets to less than 2" up to a height of 2' above ground.

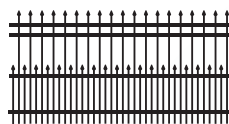

CLASSIC™



MAJESTIC™

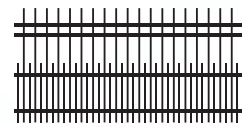

GENESIS™

NOTE: 4-rail Puppy Panels are IBC compliant.

GATE SYSTEMS

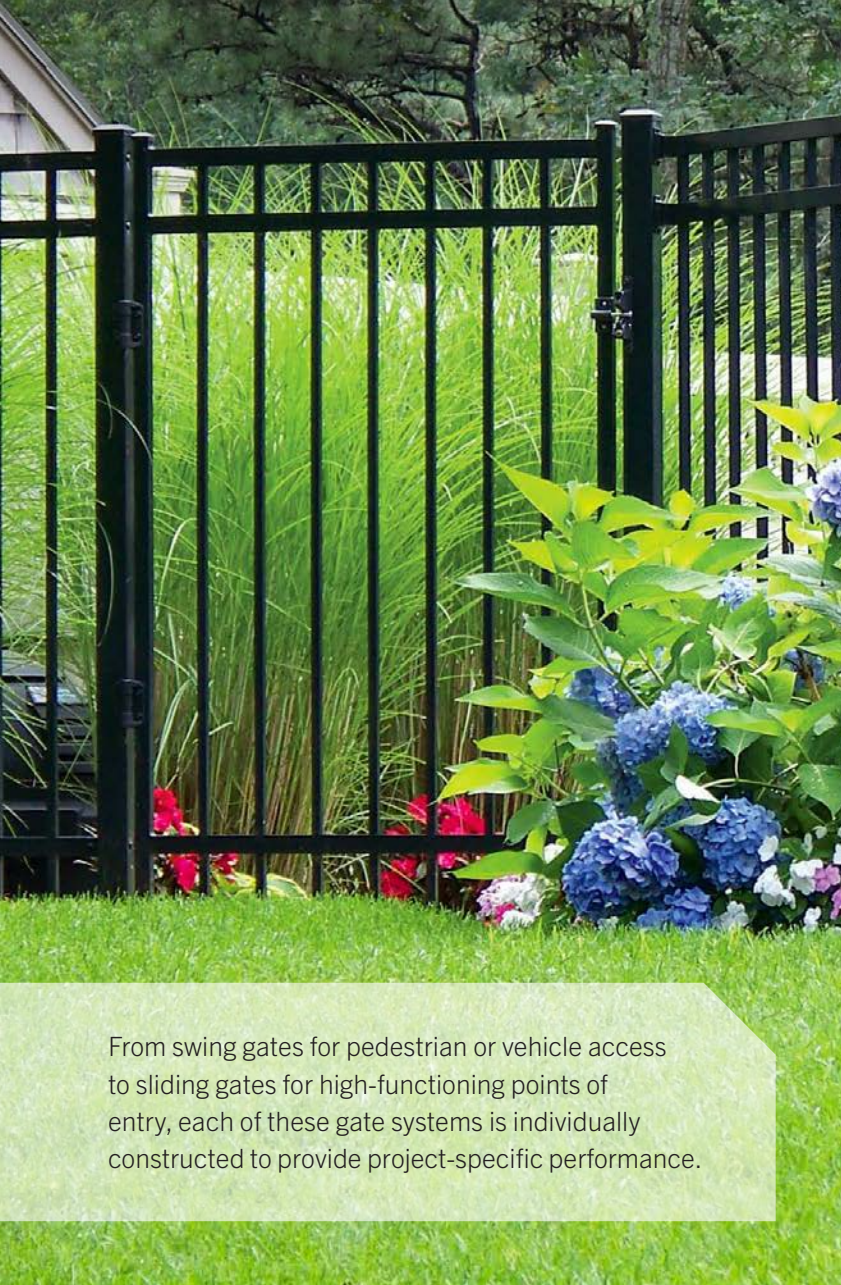

From swing gates for pedestrian or vehicle access to sliding gates for high-functioning points of entry, each of these gate systems is individually constructed to provide project-specific performance.



WALK GATE



TRANSPORT® SLIDING GATE



ARCHED GATE



ESTATE GATE

Echelon fence systems are protected to endure the elements and are maintenance free.



Echelon fence systems are backed by over 40 years of excellence in the fencing industry.



Ameristar is committed to providing products that meet the Buy American Act.



Why Choose Ameristar?

KNOWLEDGE AND EXPERIENCE

For over 40 years we've delivered aesthetically pleasing, high-quality and innovative fencing products with superior design strength and easy installation.

PROVEN CAPABILITIES

Our integrated in-house processes, extensive raw materials and finished goods inventory translate into quality, on-time delivery.

INDUSTRY LEADERSHIP

We continually raise the bar in manufacturing customer-focused solutions. Our high standards produce premium products that go beyond merely meeting minimum industry standards.

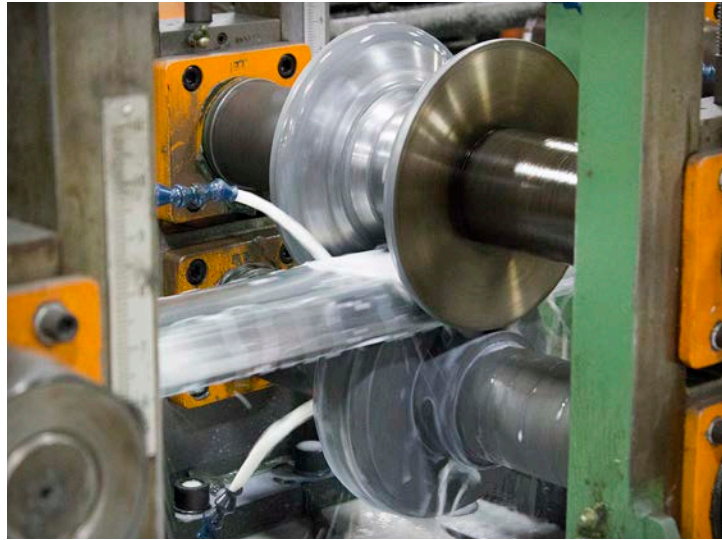

AMERISTARFENCE.COM | 888-333-3422

Experience a safer and more open world

#9729-2021

AMERISTAR®
ASSA ABLOY